

5.–7. Juli '19

Equitana Open Air Mannheim

# Western- Reitturnier

EWU-C-  
Turnier



© Fizzy-Colors

**EWU-Ranchtrophy**  
und viele weitere  
breitensportliche  
Prüfungen

**Besuchen Sie unseren EWU-Infostand auf dem Messegelände!**



**ewu** Erste Westernreiter Union  
LV Baden-Württemberg

**Der Landesverband  
Baden-Württemberg  
dankt seinen Sponsoren**

**PferdeMagazin** 

Essential Horse Balance  
Ewalia Kräutersäfte  
Gicklhorn GmbH Kunststoffverarb.  
MamaMia One of a Kind  
Nice Horse Tec  
Tierisches Traumgeflecht Jessica Kehl  
Knobel-Baugruppe  
Stallgassen Design  
Cavoil  
Cowboy-Headquarters  
PferdeMagazin  
Concho Paradies  
Starmix  
Allianz Julia Köhl  
Ätzkunst  
CG Ranch Equipment  
De-Stitches  
EquusFascia  
Gross-Okandjou Namibia  
Horse and Rider  
Lavisano Pferdefutter  
Mel's Showoutfits & More  
Pferdephysiotherapie Sarah Bucher  
Riding Boutique  
Strong Pony Anja Höfele  
Tiertherapie Lang  
Westernsaddlery California Ranch

www.essential-horse-balance.de  
www.ewalia.at  
www.gicklhorn.de  
www.mamamiaoneofakind.de  
www.nice-horse-tec.de  
www.tierisches-traumgeflecht.de  
www.knobel-bau.de  
www.stallgassen-design.com  
www.cavoil.de  
www.cowboy-headquarters.de  
www.pferde-magazin.info  
www.concho-paradies.de  
www.starmix.de  
www.allianz.de  
www.aetzkunst.de  
www.cg-ranch-equipment.de  
www.destitches.com  
www.equusfascia.de  
www.gross-okandjou.de  
www.horse-rider-reitsport.de  
www.lavisano.de  
www.mels-showoutfits.de  
www.pferdephysio-bucher.de  
www.ridingboutique.de  
www.strongpony.de  
www.tiertherapie-lang.de  
www.westernsaddlery.at

**Allianz**  **Julia Köhl**  
Vertretung der Allianz  
**Pferde OP-Versicherung**  
Julia.Koehl@allianz.de  
Mobil 0170.474.90.51



50 Years  
AWARDS FOR  
**THE BEST**



# TURNIERZEITPLAN

## Freitag

05.07.2019	Dressurplatz	
10:15:00	LK 3/4A Showmanship at Halter	Nennungen: 5
10:30:00	LK 4/5A Ranch Riding	Nennungen: 20
11:30:00	Ranch Trophy - Ranch Trail LK 4-5	Nennungen: 7
12:00:00	Ranch Trophy - Ranch Trail LK 1-3	Nennungen: 12
	<b>Pause</b>	
13:00:00	LK 3A Western Horsemanship	Nennungen: 18
13:45:00	LK 1/2A Western Horsemanship	Nennungen: 9
14:15:00	Ü40 Western Pleasure LK 3-5A	Nennungen: 3
14:30:00	LK 1/2A Western Pleasure	Nennungen: 7
14:45:00	LK 4 Reining	Nennungen: 8
15:45:00	LK 4 Trail	Nennungen: 10
16:25:00	LK 5 Trail	Nennungen: 5
16:50:00	LK 3 Trail	Nennungen: 19

**Die Trails LK 3B, 4B ud 5B wurden aufgrund mangels Teilnehmer mit den Erwachsenen zusammengelegt finden jeweils am Freitag statt.**

## Samstag

06.07.2019	Dressurplatz	
09:30:00	LK 5 Western Pleasure	Nennungen: 3
10:00:00	LK 4 Western Pleasure	Nennungen: 12
10:30:00	LK 4/5 Western Horsemanship	Nennungen: 16
11:30:00	LK 3B Western Horsemanship	Nennungen: 3
12:00:00	Ü40 Horsemanship LK 3-5A	Nennungen: 5
12:15:00	Ü40 Horsemanship LK 1-2A	Nennungen: 3
	<b>Pause</b>	
13:00:00	Ranch Trophy - Ranch Riding LK 1-3	Nennungen: 11
13:45:00	Ranch Trophy - Ranch Riding LK 4-5	Nennungen: 8
14:15:00	LK 4/5B Ranch Riding	Nennungen: 3
14:45:00	LK 1/2 Western Riding	Nennungen: 4
15:15:00	LK 1/2 sen Superhorse	Nennungen: 4
16:00:00	LK 3 Reining	Nennungen: 10

## Sonntag

07.07.2019	Dressurplatz	
09:00:00	LK 1/2 Showmanship at Halter	Nennungen: 3
09:10:00	LK 3 Western Pleasure	Nennungen: 13
09:30:00	LK 2 Ranch Riding	Nennungen: 4
09:45:00	LK 1 Ranch Riding	Nennungen: 6
10:05:00	LK 3A Ranch Riding	Nennungen: 19
10:55:00	LK 3B Ranch Riding	Nennungen: 3
11:10:00	Ranch Trophy - Rail Pleasure LK 1-3	Nennungen: 14
11:25:00	Ranch Trophy - Rail Pleasure LK 4-5	Nennungen: 7
11:40:00	Sektpleasure	Nennungen: 8
11:55:00	Führzügelklasse 4-10 Jahre	Nennungen: 3
12:05:00	Walk Trot Pleasure Jugend	Nennungen: 3
12:15:00	Walk Trot Horsemanship Jugend	Nennungen: 2
13:00:00	Trail in Hand LK 1-5	Nennungen: 6
13:30:00	LK 1/2 Horse & Dog-Trail	Nennungen: 3
	<b>Pause</b>	
14:30:00	Ü40 Trail LK 3-5A	Nennungen: 4
anschl	Ü40 Trail LK 1-2A	Nennungen: 5
anschl	LK 2 Trail	Nennungen: 5
anschl	LK 1 Trail	Nennungen: 9
anschl	Lope Over Wettbewerb LK 1-5	Nennungen: 7

**Offizielle EWU Abreizezeiten**  
 Donnerstag 04.07.2019 von 18:00 - 20:00 Uhr  
 Freitag, 05.07.2019 - 09:00 bis 1 Std. n. d. letzten Prüfung  
 Samstag, 06.07.2019 - 08:30 bis 1 Std. n. d. letzten Prüfung  
 Sonntag, 07.07.2019 - 08:00 bis Turnierende  
**Sonstige Bewegungsmöglichkeiten (auf eigene Gefahr) siehe Informationsblatt beiliegend bei Nennbestätigung**

**Öffnungszeiten der Meldestelle**  
 Donnerstag 04.07.2019 von 18:00 - 20:00 Uhr  
 Freitag, 05.07.2019 - 09:00 bis 30 Min. n. d. letzten Prüfung  
 Samstag, 06.07.2019 - 08:30 bis 30 Min. n. d. letzten Prüfung  
 Sonntag, 07.07.2019 - 08:00 bis Turnierende

Start Nr.	Reiter	LK	LV	Pferd	Rasse
11	Heike Trautwein LK 1/2 SSH ,RR LK 1-3 ,Ü40 WHS LK 1-2A ,Ü40 TH LK 1-2A	LK 1A	RLP	Nowill	Hal
13	Andreas Holl Ü40 WHS LK 1-2A ,Ü40 TH LK 1-2A ,Lope Over WB ,WPL LK 1-3 ,RR LK 1-3 ,LK 1/2 sen SUHO ,LK 1/2 WR ,LK 1 RR ,LK 1 TH	LK 1A	RLP	Black Night Star	QH
44	Melanie Böhler LK 4/5 WHS ,LK 4 TH ,LK 4 WPL ,LK 4/5 A RR ,RR LK 4-5 ,Getränke WPL	LK 4A	RLP	Del Gaucho	CRM
77	Nadine Holl TIH LK 1-5 ,WPL LK 1-3 ,LK 1/2 SSH ,Getränke WPL	LK 2A	RLP	Snowfire Sensation	PH
111	Heike Trautwein LK 1/2 A WPL ,LK 1/2 A WHS ,LK 1 TH ,LK 1 RR	LK 1A	RLP	Nonchalant	Hal
201	Susann Eichler TIH LK 1-5	LK 4A	BAWÜ	FR Prettys Red Gun	PH
202	Nicole Bender LK 3 TH	LK 3A	RLP	Hugi	LP
203	Dakota Noah Rost LK 3B RR ,LK 3 RN	LK 3B	RLP	Arc Gunshot Hickory	QH
204	Flora Eichler LK 3B WHS ,LK 3 RN ,LK 3B RR	LK 3B	BAWÜ	FR Prettys Red Gun	PH
205	Natascha Größer LK 4/5 A RR	LK 4A	RLP	Boromir	WGP
206	Christine Engel Lope Over WB ,RT LK 1-3 ,LK 1/2 sen SUHO ,WPL LK 1-3 ,RR LK 1-3 ,LK 1/2 WR ,LK 1 TH ,LK 1 RR ,LK 1/2 A WHS	LK 1A	RLP	Robin Red Pepper	QH
207	Jasmin Bär LK 4 WPL ,LK 4/5 WHS ,LK 4 RN ,LK 4/5 A RR	LK 4A	BAWÜ	Antar Rey	QH
208	Lilly Mariella Licht LK 3B RR ,LK 3B WHS ,LK 3 TH	LK 3B	RLP	Robin Red Pepper	QH
209	Christine Petri LK 3A WHS ,LK 3 WPL ,LK 3 TH ,LK 3A RR ,Ü40 WPL LK 3-5A ,Ü40 WHS LK 3-5A ,Ü40 TH LK 3-5A	LK 3A	RLP	Zippers Flashback	QH
210	Daniela Surmund Ü40 WHS LK 3-5A ,Ü40 TH LK 3-5A ,LK 3 RN ,LK 3A RR ,LK 3 WPL ,LK 3A WHS ,LK 3/4 A SSH ,LK 3 TH	LK 3A	BAWÜ	Kims Awesome Freckle	QH
211	Jule Pape LK 4/5 WHS	LK 4B	HES	Bigs Glory Jewel	QH
212	Barbara Dechant LK 3 TH ,WPL LK 1-3 ,LK 3A RR	LK 3A	RLP	UT Golden Clark	APP
213	Martina Deigentash WPL LK 1-3 ,LK 3A RR ,LK 3 TH ,LK 3A WHS	LK 3A	RLP	Django Such Olena	PH
214	Tanja Schwarz RT LK 1-3 ,WPL LK 1-3 ,RR LK 1-3 ,LK 2 TH	LK 2A	SAAR	Claro De Luna	CR
215	Sarah Maria Frohnmayer LK 4/5 WHS ,LK 4 WPL ,LK 4/5 A RR ,LK 4 RN	LK 4A	BAWÜ	Someone Special Leo	QH
216	Nadja Götzte LK 3A WHS ,LK 3/4 A SSH ,LK 3 WPL ,LK 3 TH ,LK 3A RR ,WPL LK 1-3 ,RR LK 1-3 ,TIH LK 1-5 ,RT LK 1-3 ,Getränke WPL	LK 3A	BAWÜ	Cheeky Little Baily	QHM
217	Sonja Buchner LK 3A WHS ,LK 3A RR ,RR LK 1-3	LK 3A	BAWÜ	Miss Sugar Montana	Poln.WB

## TEILNEHMERLISTE

218 Sonja Buchner RT LK 1-3 ,LK 3 RN ,LK 3 WPL	LK 3A	BAWÜ	Royal Pepsi Coke	QH
219 Nina Fetting LK 3A RR ,RT LK 1-3 ,WPL LK 1-3 ,LK 3 TH	LK 3A	RLP	Belle	TI
220 Sonja Theobald LK 3 RN	LK 3A	HES	Lethal Surprise	QH
221 Lena Henkelmann LK 3 RN ,LK 3A RR	LK 3A	HB/NS	Ms rooster kid	QH
222 Svenja Haberstroh Lope Over WB ,LK 4/5 WHS ,LK 4/5 A RR ,LK 4 RN	LK 4A	BAWÜ	EH Most Like Smooth	QH
223 Daniela Sauter TiH LK 1-5 ,LK 1 RR ,LK 1 TH ,LK 1/2 A WPL ,LK 1/2 A WHS ,Ü40 TH LK 1-2A	LK 1A	SAAR	Badgers Sweet Mystery	WGP
224 Hannah Pape LK 4/5 B RR	LK 4B	HES	Bigs Glory Jewel	QH
226 Nancy Baltzley LK 1 RR	LK 1A	RLP	WH Doc Jac	QH
227 Daniela Marquardt LK 3 TH ,LK 3A WHS ,LK 3A RR	LK 3A	RLP	Whiz Golden Dust	QH
228 Holger Heid Lope Over WB ,WPL LK 4-5 ,Getränke WPL	LK 4A	HES	FXBailey Smart Reina	QH
229 Kim Gärtner WPL LK 1-3 ,RT LK 1-3 ,LK 3A RR ,LK 3 TH ,LK 3A WHS ,LK 3 WPL	LK 3A	RLP	Leo	FRE
230 Sabrina Schwab LK 3 RN	LK 3A	BAWÜ	Buckys Gentlemen	QH
231 Melanie Moser LK 4/5 A RR ,LK 4 WPL ,LK 4/5 WHS	LK 4A	BAWÜ	Prosecco	DRP
232 Teresa Marquardt FZ	LK 5B		Whiz Golden Dust	QH
233 Lilly Zipperer LK 4 WPL ,LK 4/5 B RR ,RT LK 4/5 ,WPL LK 4-5 ,RR LK 4-5	LK 4B	BAWÜ	Cheeky Little Baily	QHM
234 Sabrina Ulbrich LK 1/2 sen SUHO ,RT LK 1-3 ,WPL LK 1-3 ,LK 1/2 WR ,LK 1/2 A WPL ,LK 1/2 A WHS ,LK 1 TH ,Lope Over WB ,Getränke WPL ,RR LK 1-3	LK 1A	BAWÜ	One Hollywood Dunit	QH
235 Thomas Jung LK 5 TH ,LK 4/5 WHS ,LK 5 WPL ,Ü40 TH LK 3-5A ,Ü40 WHS LK 3-5A ,Ü40 WPL LK 3-5A	LK 5A		Aponi	PH
236 Sarah Sauter LK 1/2 sen SUHO ,LK 1/2 A WHS ,LK 1/2 A WPL ,LK 1 RR ,LK 1 TH	LK 1A	SAAR	Arc Sweet Gun Oak	QH
237 Tabea Christine Zeller LK 4/5 A RR ,RT LK 4/5 ,WPL LK 4-5 ,TiH LK 1-5 ,LK 4 WPL ,LK 3/4 A SSH ,LK 4/5 WHS ,LK 4 TH ,RR LK 4-5	LK 4A	BAWÜ	Apanachi	WGP
238 Kerstin Storeck LK 4/5 WHS ,LK 4 WPL ,LK 4/5 A RR	LK 4A	RLP	Lacora Okla Homa Soe	CON/HAL
239 Boris Linz-Bucher Ü40 TH LK 3-5A ,RT LK 1-3 ,Ü40 WPL LK 3-5A ,Ü40 WHS LK 3-5A ,LK 3A RR ,LK 3 RN ,LK 3 TH ,LK 3 WPL ,LK 3A WHS	LK 3A	BAWÜ	Big Step Cathy Jane	PH
240 Sarah Bucher RR LK 1-3 ,LK 3A RR ,LK 3 RN	LK 3A	BAWÜ	Bonny´s Big Skip	QH
241 Sandra Barthel LK 3 TH ,LK 3 WPL ,LK 3A WHS	LK 3A	BAY	A Starlight Rose	QH

242 Thomas Eimer Ü40 TH LK 1-2A ,LK 2 TH	LK 2A	HES	Naz	Hal
243 Claudia Weiland LK 2 TH ,Ü40 TH LK 1-2A	LK 2A	HES	Agitano BE	Hal
244 Lena Hannemann LK 3A RR ,LK 3 WPL ,LK 3A WHS	LK 3A	SAAR	Arc Sweet Gun Oak	QH
245 Beatrix Herrmann LK 3A WHS	LK 3A	HES	Miss Susi Hollywood	QH
246 Saskia Voss RR LK 4-5 ,LK 4/5 WHS ,WPL LK 4-5 ,RT LK 4/5 ,LK 4 RN ,LK 4/5 A RR	LK 4A	BAWÜ	Playin Hard BH	QH
247 Sonja Zörgiebel-Bayer LK 1/2 A WHS ,LK 1 TH ,Lope Over WB	LK 1A	RLP	Oz	FJ
248 Holger Birkle LK 1/2 A WHS ,LK 1/2 A WPL ,LK 2 TH	LK 2A	RLP	Sienna Simkabardunit	QH
249 Sandra Ellering RR LK 1-3 ,LK 1/2 WR ,Ü40 WHS LK 1-2A	LK 2A	RLP	Diamonds King Smoky	QH
250 Lilly Dinges RT LK 4/5 ,WPL LK 4-5 ,LK 4/5 B RR ,LK 4/5 WHS ,LK 5 TH ,RR LK 4-5	LK 5B	RLP	Najavaio	Son.P
251 Jana Hauck LK 3A RR ,LK 3 TH ,LK 3 WPL ,LK 3A WHS ,Getränke WPL	LK 3A	RLP	Bandito	CR
252 Doreen Kaufeld LK 4 TH ,LK 4/5 A RR ,LK 4 RN	LK 4A	RLP	DK Attilas Famoust	Hal
253 Nadja Wilhelm LK 4/5 WHS ,LK 4 WPL ,Ü40 WHS LK 3-5A	LK 4A	BAWÜ	Mec Malones Princess	APP
254 Meike Peter LK 4 WPL ,LK 4 TH ,LK 4 RN ,LK 4/5 A RR	LK 4A	BAWÜ	DR Daddys Little Sun	QH
255 Jo-Ann Paniagua LK 5 WPL	LK 5A		Follow Lika Ghost	WGP
256 Julia Schäfer RR LK 4-5 ,LK 4/5 WHS ,LK 4 WPL ,LK 3/4 A SSH ,LK 4/5 A RR ,TiH LK 1-5	LK 4A	BAWÜ	Doc Nubbins Queen	QH
257 Manfred Baltruschat LK 3A WHS ,LK 3 WPL ,LK 3 TH ,LK 3A RR	LK 3A	RLP	Okies Rosa Listo	QH
258 Simone Petri LK 2 TH ,LK 2 RR ,LK 1/2 SSH	LK 2A	RLP	Mr Cherokee Cowboy	PH
259 Nadine Wittling WPL LK 1-3 ,RR LK 1-3 ,RT LK 1-3	LK 2A	SAAR	Mb Maximus	PH
260 Lilly Wittling RT LK 4/5 ,WPL LK 4-5 ,RR LK 4-5	LK 4B	SAAR	Mb Maximus	PH
263 Benedicta Stöcklein LK 1/2 A WHS ,LK 1 TH ,RT LK 1-3 ,Lope Over WB	LK 1A	RLP	Whiz My Advocate	QH
264 Angela Innetsberger LK 3 TH ,LK 3/4 A SSH ,LK 3A WHS	LK 3A	RLP	FR Chexes First Gun	PH
265 Sandra Kaiser LK 4/5 A RR ,LK 4 TH ,LK 4/5 WHS ,LK 4 WPL	LK 4A	RLP	Romeo	WEL-M
266 Thurid Nanna Gauda LK 4 TH ,LK 4 RN ,LK 4/5 A RR	LK 4A	BAWÜ	CK Indigo	APP
267 Sabrina Gadinger LK 3A RR ,LK 3 TH ,LK 3A WHS ,LK 3 WPL ,Getränke WPL	LK 3A	RLP	High Spirit TH	QH

## TEILNEHMERLISTE

268 Cordula Rumig LK 4 WPL ,LK 4 TH ,LK 4/5 WHS ,LK 4/5 A RR	LK 4A	BAWÜ	Touch Screen	QH
269 Jorina Vogler LK 4 TH ,LK 4 RN ,LK 4/5 A RR ,RT LK 4/5 ,WPL LK 4-5 ,RR LK 4-5	LK 4A	BAWÜ	HR Touch Of Cinnamon	QH
270 Katharina Krefß LK 3B WHS ,LK 3 WPL ,LK 3 RN ,WPL LK 1-3	LK 3B	BAWÜ	MA Starfighter	APP
271 Hanna Meyer LK 3 TH ,LK 3A WHS	LK 3A	BAWÜ	CK Indigo	APP
272 Dana Bohlender LK 1/2 A WPL ,LK 2 RR ,WPL LK 1-3	LK 2A	HES	Cinnamon Gun	PH
273 Alexandra Grabenauer LK 3A RR ,LK 3 TH ,LK 3A WHS	LK 3A	RLP	Danuri	SK
274 Christian Grabenauer LK 2 RR ,LK 1/2 A WPL ,LK 1/2 A WHS	LK 2A	RLP	Doc Sparkling Cutter	QH
275 Sina Elsigk RR LK 1-3 ,LK 2 RR	LK 2A	SAAR	GS Great Sun Berry	QH
276 Vicky Roos LK 3 WPL ,LK 3A WHS ,LK 3 TH ,LK 3A RR ,RT LK 1-3 ,WPL LK 1-3	LK 3A	RLP	Royal Big Bar Billy	PH
277 Marius Bayer	LK 5A		Oz	FJ
278 Melissa Gonzalez Lopez WT WHS B ,WT WPL B	LK 5B		Junon	WGP
279 Silke Ehrenberger LK 3A RR ,RT LK 1-3	LK 3A	BAWÜ	Atoll 165	Hal
280 Daniela Fischer RT LK 4/5 ,LK 4/5 A RR	LK 4A	BAWÜ	Atoll 165	Hal
281 Lena Ziegelhöfer WT WPL B	LK 5B		Cita Chic Olena	QH
282 Charlotte Gögge FZ	LK 5B		Cita Chic Olena	QH
283 Sarah Föhn Getränke WPL	LK 5A		Django Such Olena	PH
284 Laura Sick LK 4/5 A RR ,LK 5 TH	LK 5A		Cinnamon Gun	PH
285 Jasmin Birau LK 4/5 WHS ,LK 4 TH	LK 4A	RLP	Jerseys Golden Girl	QH
286 Wolfgang Wagner LK 1 TH	LK 1A	RLP	Blacks Invitation	QH
287 Alexander Birau FZ	LK 5B		Jerseys Golden Girl	QH
288 Andrea Engelhardt-Skarke LK 4/5 A RR ,LK 5 TH	LK 5A		Felicia	CR
289 Birgit Schopf LK 4/5 A RR ,LK 4 TH	LK 4A	BAWÜ	Chic Sandman	QH
290 Julia Ludwig LK 5 WPL ,LK 5 TH	LK 5A		DR Daddys Little Sun	QH
291 Enja Bradasch WT WPL B ,WT WHS B	LK 5B		Nelja	Wel.A
292 Jacqueline Gulden-Schütz LK 1/2 H&D TH	LK 1A	RLP	Anja	Hal

Western Riding

LK 1/2 A/B                      Pattern 6

Senior Superhorse (2018)

LK 1/2 A/B                      Pattern 1

Reining

LK 3 A/B                        Pattern 6

LK 4 A/B                        Pattern 14

Ranch Riding (12/2017)

LK 1 A/B                        Pattern 13

LK 2 A/B                        Pattern 13

LK 3 A                          Pattern 2

LK 3 B                          Pattern 2

LK 4/5 A/B                      Pattern 3

Trophy LK 1-3                Pattern 9

Trophy LK 4-5                Pattern 8





Trail Horse LK 3 A/B

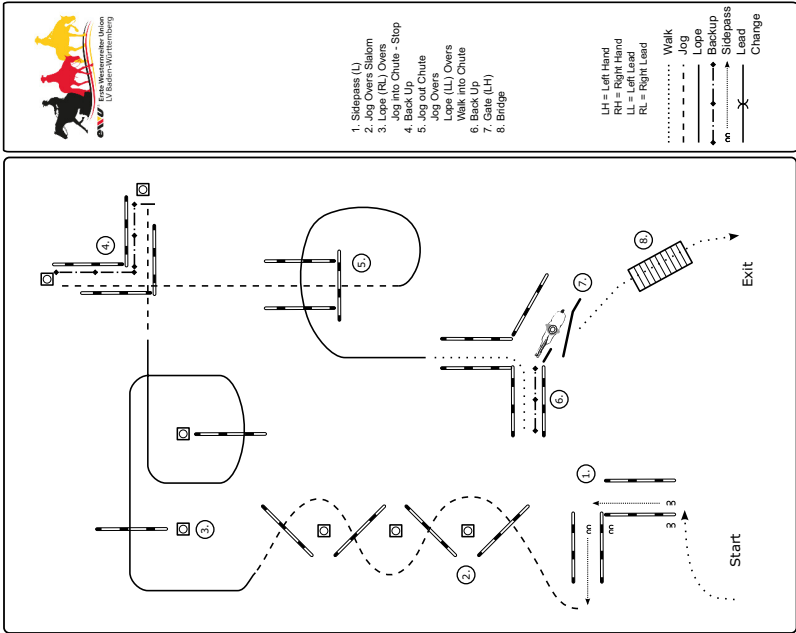

Trail Horse LK 1/2 A/B

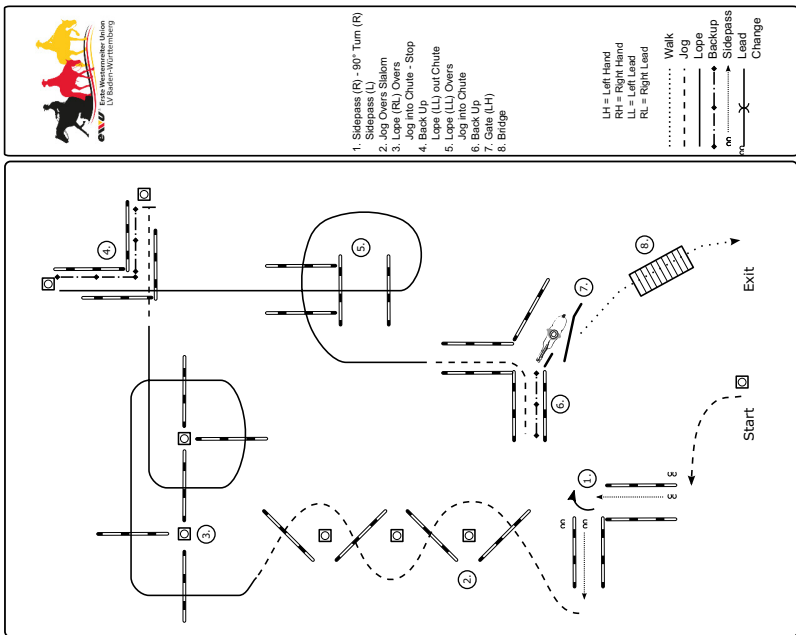

Trail Horse LK 5 A/B



Erste Westernreiter Union  
in Baden-Württemberg

1. Sidepass (L)
2. Jog Overs Slalom
3. Lope (RL)
4. Back Up
5. Jog out Chute
6. Jog Overs
7. Walk into Chute
8. Bridge

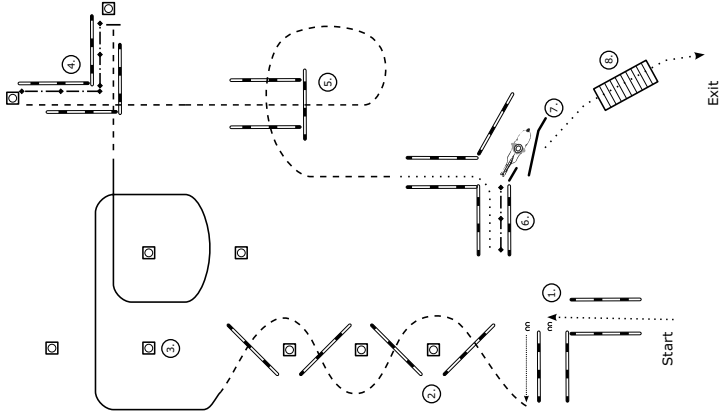
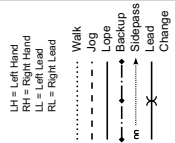

Trail Horse LK 4 A/B



Erste Westernreiter Union  
in Baden-Württemberg

1. Sidepass (L)
2. Jog Overs Slalom
3. Lope (RL)
4. Jog into Chute - Stop
5. Jog out Chute
6. Lope (LL or RL) Overs
7. Jog Overs
8. Walk into Chute
9. Back Up
9. Gate (L/H)
9. Bridge

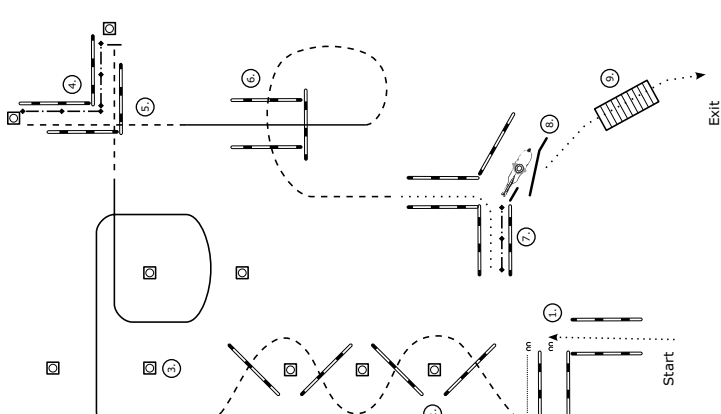
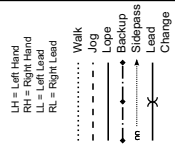

Trail Horse Ü40 LK 1-2A

Erste Westreitner Union  
EUROPEAN WESTERN RIDING UNION  
EUROPEAN WESTERN RIDING UNION

1. Bridge
2. Gate (LH)
3. Back Up
4. Walk out Chute
5. Lope (RL) Overs
6. Jog into Chute
7. Jog Chute
8. Lope (LL) Overs
9. Jog Overs
10. Sidepass (L)

LH = Left Hand  
RH = Right Hand  
LL = Left Lead  
RL = Right Lead

..... Walk  
- - - - - Jog  
- - - - - Lope  
- - - - - Backup  
- - - - - Sidepass  
- - - - - Lead  
X Change

Trail Horse In Hand LK 1-5

Erste Westreitner Union  
EUROPEAN WESTERN RIDING UNION  
EUROPEAN WESTERN RIDING UNION

1. Walk Overs
2. Jog Overs Sialom
3. Jog Overs
4. Walk into Chute - Stop
5. Back Up
6. Walk out Chute
7. Jog Overs
8. Gate (LH)
9. Bridge

LH = Left Hand  
RH = Right Hand  
LL = Left Lead  
RL = Right Lead

..... Walk  
- - - - - Jog  
- - - - - Lope  
- - - - - Backup  
- - - - - Sidepass  
- - - - - Lead  
X Change

**Ranch Trail LK 1-3**



1. Tor
2. Spinnade rechts
3. Brücke
4. Lope Over
5. Back Up
6. Walk Over
7. Jog Drag
8. Regenanfälle anziehen
9. Walk Out

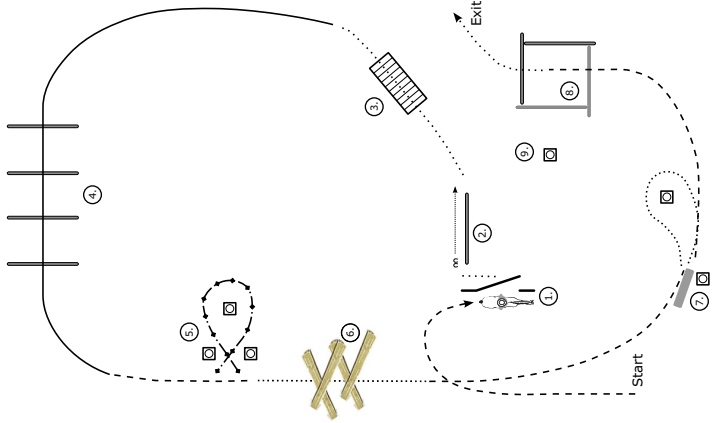
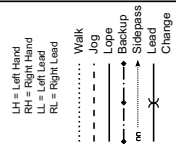

**Trail Horse Ü40 LK 3-5A**



1. Bridge
2. Gate (RH)
3. Back Up
4. Walk out Chute
5. Jog into Chute
6. Back Up
7. Jog out Chute
8. Lope (LL) Overs
9. Jog Overs (-)
8. Sidepass (-)

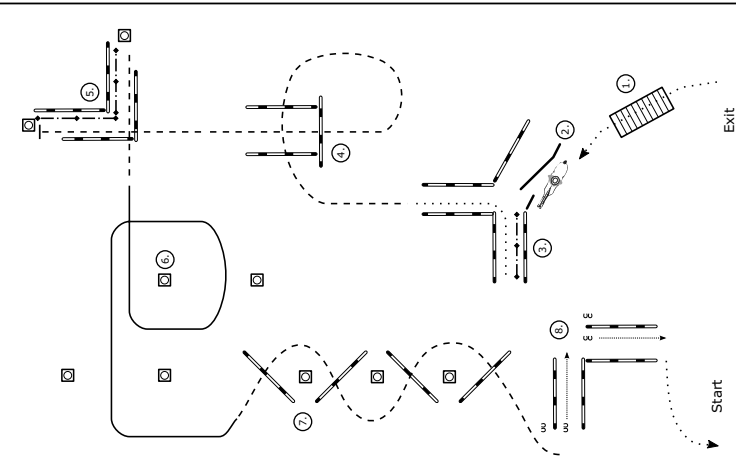
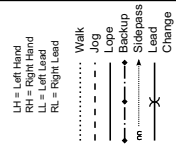

### Ranch Trail LK 4-5

1. Tor
2. Steilwärts rechts
3. Brücke
4. Jog
5. Back Up
6. Walk Over
7. Jog Over
8. Rope auf Pferdekopf (2 Versuche)
- Walk Out

LH = Left Hand  
RH = Right Hand  
LL = Left Lead  
RL = Right Lead

..... Walk  
 - - - - - Lope  
 - - - - - Backup  
 - - - - - Jog  
 ——— Lead  
 ——— Change

---

### Showmanship at Halter LK 1A / LK 1B / LK 2A / LK 2B

Set Up bei A

1. Walk bei B - Stop
2. 180° Turn
3. Back Up
4. Jog
5. 270° Turn
6. Back Up
7. 270° Turn

Jog in dein Warm Up Bereich

[A] Marker  
 ..... Walk  
 - - - - - Jog  
 - - - - - ext. Jog  
 ——— Back Up

Western Horsemanship LK 1/2 A



1. Walk zu A
2. Jog bis hinter B - Stop
3. 270° Turn (L)
4. Walk zwischen B und C
5. + großer Zirkel (L) ext. Lope
6. + Lead Change (fly / simple)
7. + kleiner Zirkel (R)
8. Walk zwischen C und D
9. 270° Turn (R)
10. Jog bis hinter C - Stop
11. 270° Turn (L)
12. Jog bis D - Stop
13. Back Up
14. Jog in Warm Up Area

- L = Left  
R = Right  
LL = Left Lead  
RL = Right Lead
- A** Marker  
..... Walk  
- - - - - Jog  
- - - - - ext. Jog  
- - - - - Lope  
- - - - - ext. Lope  
- - - - - Back Up  
- - - - - Sidewalk  
- - - - - Sidewalk  
- - - - - Lead  
- - - - - Change

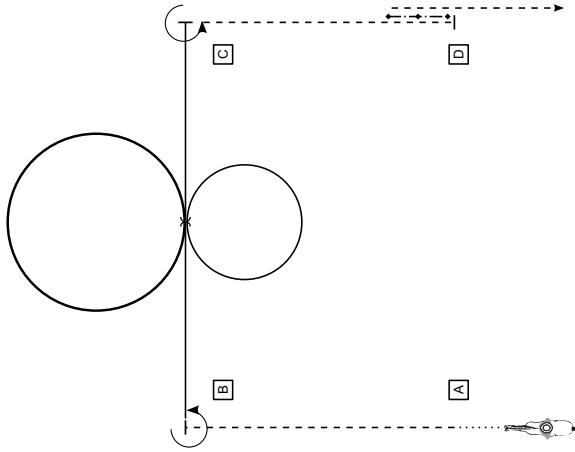

Showmanship at Halter LK 3/4 A



- Set Up bei A
1. Walk bis B - Stop
  2. 180° Turn
  3. ab 2 Pferdehänge
  4. 270° Turn
  5. Walk zum Richter
  6. Stop Set Up
  7. 270° Turn
  8. Walk in dem Warm Up Bereich

- A** Marker  
..... Walk  
- - - - - Jog  
- - - - - ext. Jog  
- - - - - Back Up

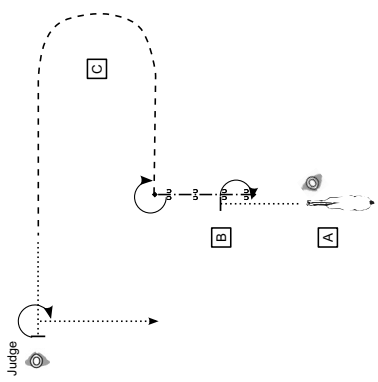

Western Horsemanship LK 4A / LK 4B / LK 5A / LK 5B



1. Walk zu A
2. Jog bis hinter B - Stop
3. 270° Turn (L)
4. Jog bis hinter B und C
5. + Lope (RL)
6. + großes Zirkel (R)
7. + Jog
8. kleiner Zirkel (L)
9. Jog bis hinter C - Stop
4. 90° Turn (R)
5. Jog bis D - Stop
6. Back Up
- Walk in Warm Up Area

L = Left  
R = Right  
LL = Left Lead  
RL = Right Lead

**A** Marker

..... Walk  
----- Jog  
----- ext. Jog  
----- Lope  
----- ext. Lope  
----- Backup  
----- Stop  
----- m → 3 → 5 → Change  
----- Lead

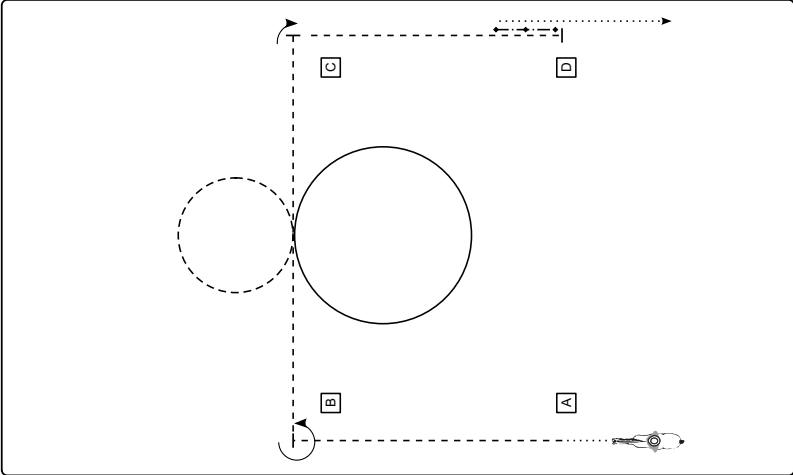

Western Horsemanship LK 3A / LK 3B



1. Walk zu A
2. Jog bis hinter B - Stop
3. Lope (LL)
4. Jog bis hinter B und C
5. + Lead Change (lv / simple)
6. + großes Zirkel (R)
7. + Jog kleiner Zirkel (L)
8. Jog bis hinter C - Stop
9. Jog bis D - Stop
6. Back Up
- Walk in Warm Up Area

L = Left  
R = Right  
LL = Left Lead  
RL = Right Lead

**A** Marker

..... Walk  
----- Jog  
----- ext. Jog  
----- Lope  
----- ext. Lope  
----- Backup  
----- Stop  
----- m → 3 → 5 → Change  
----- Lead

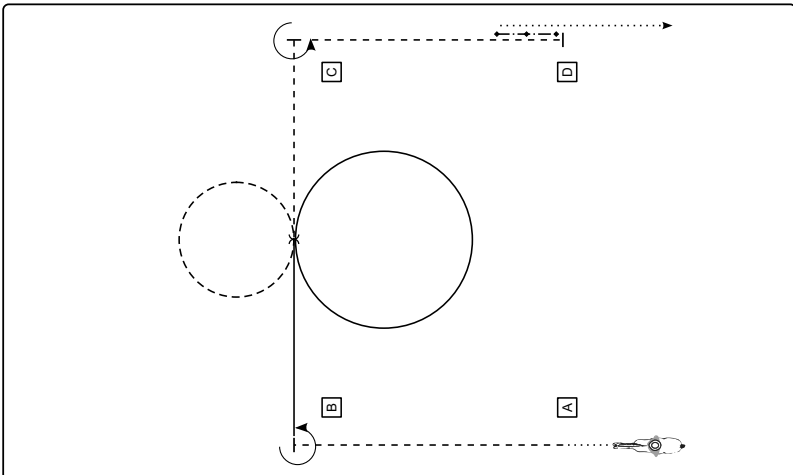

Western Horsemanship Ü40 LK 1-2A



1. Walk, Jog to middle
2. Stop, 360° Turn (L)
3. Lope (L) to edge
4. Change lead (fly-ample)
5. Lope (R) and back to middle
6. Exit Trot through turn to middle
7. Stop
8. 360° Turn (R), Back Up
9. Exit at Jog

- L = Left  
R = Right  
Ll = Left Lead  
Rl = Right Lead
- A** Marker
- ..... Walk
  - ..... Jog
  - ext. Jog
  - Lope
  - ext. Lope
  - Backup
  - Sidepass
  - Lead
  - Change

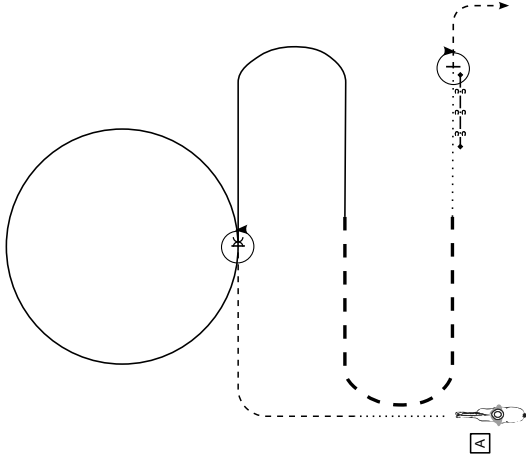

Western Horsemanship W-T Jugend



1. Walk on A
2. Jog bis hinter B - Stop
3. 270° Turn (L)
4. Jog zwischen B und C + ext. Jog großes Zirkel (R)
5. 90° Turn (L) hinter C
6. Jog bis hinter C - Stop
7. 90° Turn (R)
8. Jog bis D - Stop
9. Back Up
10. Walk in Warm Up Area

- L = Left  
R = Right  
Ll = Left Lead  
Rl = Right Lead
- A** Marker
- ..... Walk
  - ..... Jog
  - ext. Jog
  - Lope
  - ext. Lope
  - Backup
  - Sidepass
  - Lead
  - Change

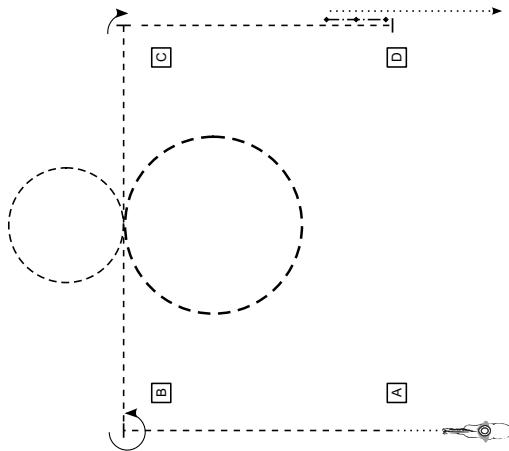



### Horse & Dog Trail LK 1-2

Erste Westernreiter Union  
E-Post: EWU@westernreiter.de  
17 Süßen/Württemberg

1. Einreiten an Pylone anhalten  
+ Hund ablassen
2. Walk into Chute, Sidepass (L)  
+ Hund bei Fuß, atlegen
3. Jog über nachrufen  
+ Hund bei Fuß
4. Lope (RL) Over, Jog into Chute, Stop  
+ Hund bei Fuß
5. Backup  
+ Hund an Pylone ablegen
6. Jog am Sprung vorbei  
Walk into Chute, Stop  
+ Hund springt über Sprung
7. Back Up  
+ Hund bei Fuß
8. Tor  
+ Hund durch das Tor rein
9. Walk über Brücke  
+ Hund voraus schicken
10. Anhalten, absteigen  
Hund anleinen

LH = Left Hand  
RH = Right Hand  
LL = Left Lead  
RL = Right Lead

..... Walk  
- - - - - Jog  
- - - - - Lope  
- - - - - Backup  
- - - - - Sidepass  
m ----- Lead  
X ----- Change

### Western Horsemanship Ü40 LK 3-5A

Erste Westernreiter Union  
E-Post: EWU@westernreiter.de  
17 Süßen/Württemberg

1. Walk, Jog to middle
2. Stop, 360° Turn (L)
3. Lope (L) a Circle
4. Jog through turn to middle
5. Stop
6. Jog through turn to middle
7. Walk, Stop
8. 360° Turn (R), Back Up
9. Exit at Jog

L = Left  
R = Right  
LL = Left Lead  
RL = Right Lead

[A] Marker  
..... Walk  
- - - - - Jog  
- - - - - ext. Jog  
- - - - - Lope  
- - - - - ext. Lope  
- - - - - Backup  
- - - - - Sidepass  
m ----- Lead  
X ----- Change

§ 7842 Reining-Pattern 14 (nur für LK 4)

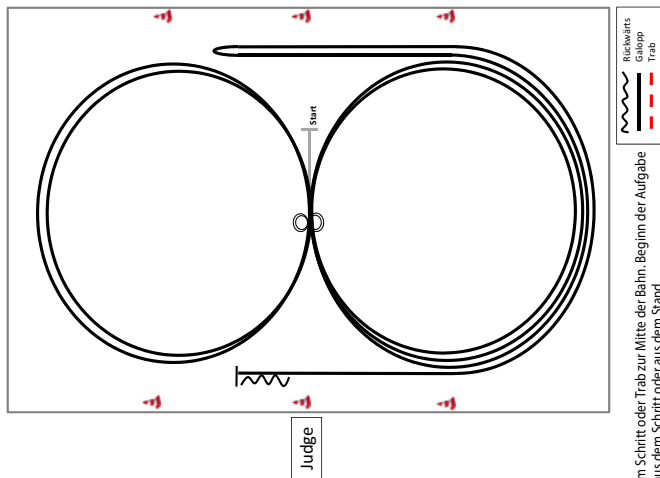

Im Schritt oder Trab zur Mitte der Bahn, Beginn der Aufgabe aus dem Schritt oder aus dem Stand.

- 1) 2 Zirkel Galopp (links), stop bei X, Verharren.
- 2) 2 Spins links, verharren.
- 3) 2 Zirkel Galopp (rechts), stop bei X, Verharren.
- 4) 2 Spins rechts, verharren.
- 5) Galopp (links) auf dem Zirkel, der nicht geschlossen wird, run down entlang der langen Seite, sliding stop mind. 6m von der Bande entfernt hinter dem **Mittelmarker**, rollback rechts, kein Verharren.
- 6) Galopp (rechts) auf dem Zirkel, der nicht geschlossen wird, run down entlang der langen Seite, sliding stop mind. 6m von der Bande entfernt hinter dem **Mittelmarker**, Rückwärtsrichten mind. 3m, verharren.

Der Reiter muss das Kopfstück zur Gebisskontrolle vor dem Richter abnehmen.

§ 7830 Reining-Pattern 6

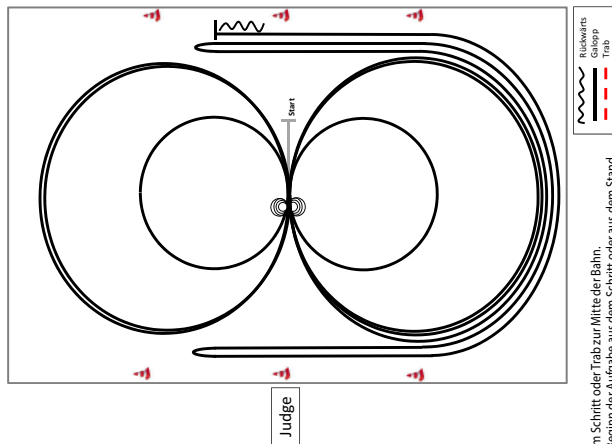

Im Schritt oder Trab zur Mitte der Bahn, Beginn der Aufgabe aus dem Schritt oder aus dem Stand.

- 1) 4 Spins rechts, verharren.
- 2) 4 Spins links, verharren.
- 3) 2 Zirkel Galopp (links), 1+2 groß und schnell, 3 klein und langsam, 4 gegenüberüber bei X, verharren.
- 4) 2 Zirkel Galopp (rechts), 1+2 groß und schnell, 3 klein und langsam, 4 gegenüberüber bei X, verharren.
- 5) Galopp (links) auf dem Zirkel, der nicht geschlossen wird, run down entlang der langen Seite, sliding stop mind. 6m von der Bande entfernt hinter dem **Mittelmarker**, rollback rechts, kein Verharren.
- 6) Galopp (rechts) auf dem Zirkel, der nicht geschlossen wird, run down entlang der langen Seite, sliding stop mind. 6m von der Bande entfernt hinter dem **Mittelmarker**, rollback links, kein Verharren.
- 7) Galopp (links) auf dem Zirkel, der nicht geschlossen wird, run down entlang der langen Seite, sliding stop mind. 6m von der Bande entfernt hinter dem **Mittelmarker**, Rückwärtsrichten mind. 3m, verharren.

Der Reiter muss das Kopfstück zur Gebisskontrolle vor dem Richter abnehmen.

Pattern RR #3: LK 4/5 A/B  
Arenagröße: mind. 20x40m

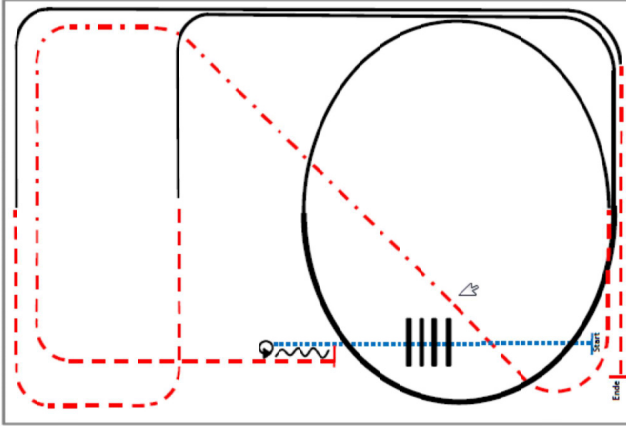

- 1) Walk.
- 2) Walk over: walk.
- 3) Stop, 360° turn left or right.
- 4) Back.
- 5) Trot.
- 6) Extended trot, trot.
- 7) Lope left lead.
- 8) Extended lope, lope.
- 9) Trot.
- 10) Lope right lead.
- 11) Trot, stop.

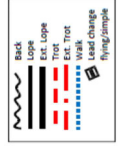

Pattern RR #2: LK3 A/B  
Arenagröße: mind. 20x40m

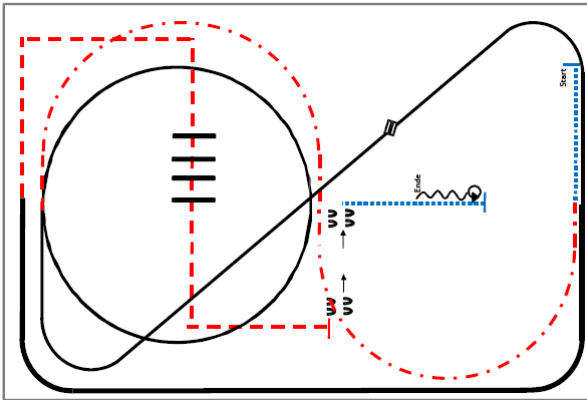

- 1) Walk.
- 2) Extended trot, trot.
- 3) Lope left lead one circle, lope left lead.
- 4) Leadchange.
- 5) Lope right lead.
- 6) Extended lope.
- 7) Trot corners.
- 8) Trot over, trot.
- 9) Stop, sidepass left.
- 10) Walk, stop.
- 11) 360° turn right or left, back.

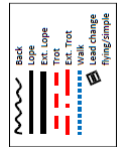

Pattern RR #8: LK 4/5 A/B  
Arenagröße: mind. 20x40

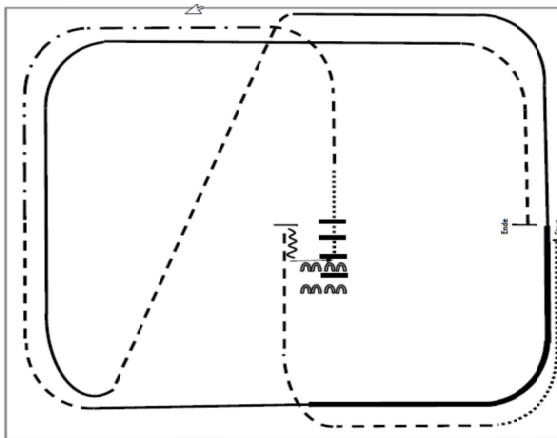

1. Walk
2. Trot
3. Stop, Back
4. Sidepass right 1/2 way
5. Walk over
6. Trot
7. Ext. Trot, Trot
8. Lope left lead
9. Ext. Lope left lead
10. Lope left lead
11. Trot
12. Lope right lead
13. Trot, Stop

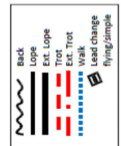

Pattern RR #9: LK3 A/B  
Arenagröße: mind. 20x40m

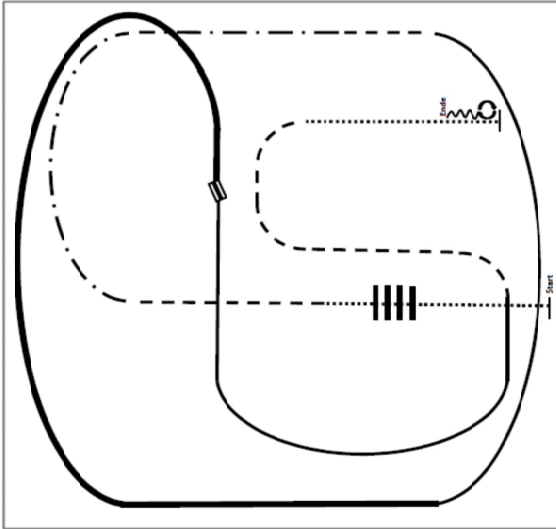

1. Walk over
2. Trot
3. Ext. Trot, Trot
4. Lope right lead
5. Ext. Lope right lead
6. Change leads
7. Lope left lead
8. Trot
9. Walk
10. Stop, Turn 360° each direction (either way first)
11. Back

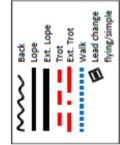

57607 Western Riding - Pattern 6 (für Junior Pferde)

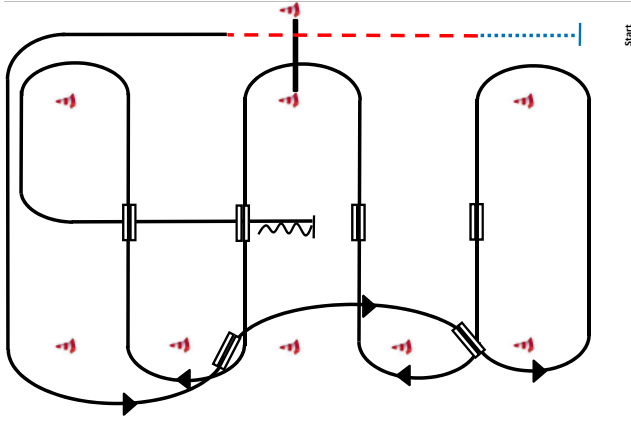

- 1) Schritt, Übergang zum Trab zwischen den ersten beiden Markern, Trab über die Stange.
- 2) Übergang zum Linksgalopp innerhalb von 9m nach der Stange, Galopp an der kurzen Seite.
- 3) 1. Galoppwechsel auf der Linie.
- 4) 2. Galoppwechsel auf der Linie.
- 5) 1. Galoppwechsel mit Seitenwechsel.
- 6) 2. Galoppwechsel mit Seitenwechsel.
- 7) Galopp über die Stange.
- 8) 3. Galoppwechsel mit Seitenwechsel.
- 9) 4. Galoppwechsel mit Seitenwechsel, stop auf Höhe des Mittelmarkers, Rückwärtsrichten mind. 3m.

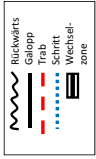

Pattern RR #13: LK 1/2 A/B sen  
Arenagröße: mind. 20x40m

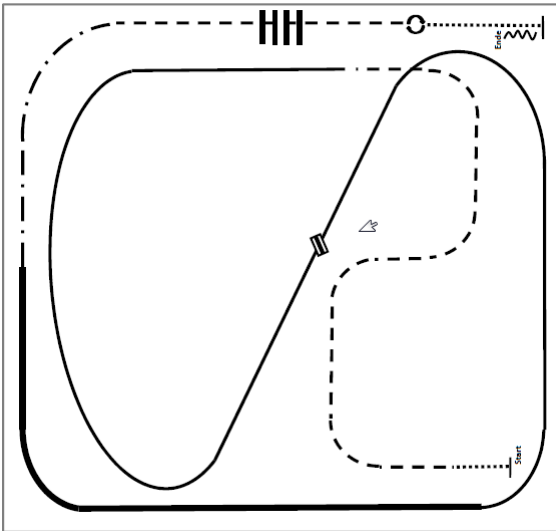

1. Walk
2. Trot
3. Lope left lead
4. Change leads
5. Lope right lead
6. Ext. Lope right lead
7. Ext. Trot
8. Trot
9. Trot over
10. Stop, Turn 360° each direction (either way first)
11. Walk, Stop, Back

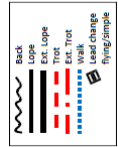

**Pattern SUHO 2018 #1:  
(Empfohlen für Hallen oder Plätze ab 20x40m)**

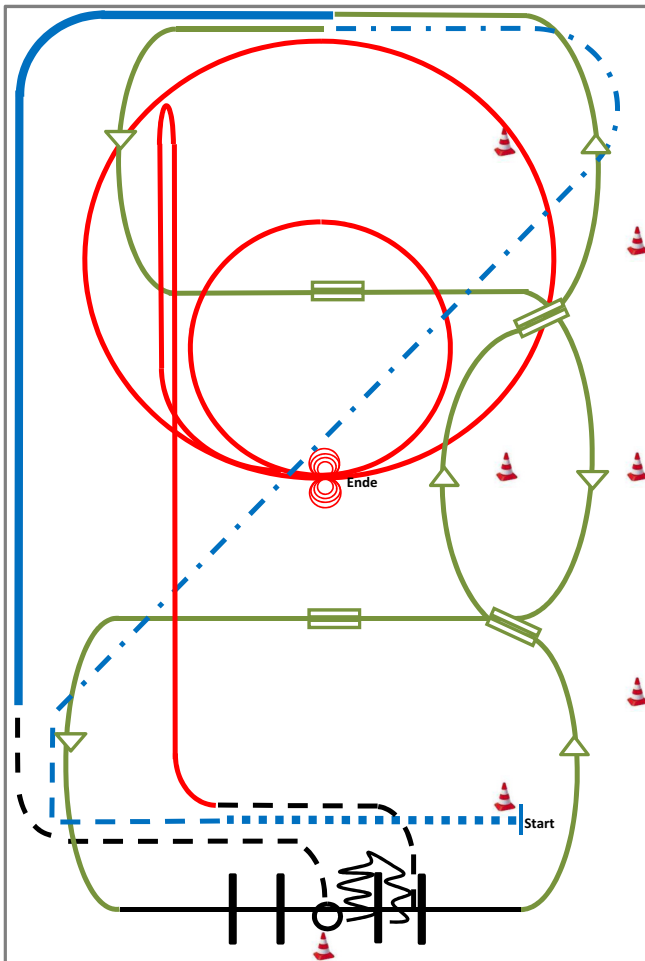

- 1) extended walk (RR)
- 2) trot, extended trot (RR)
- 3) Galoppwechsel mit Seitenwechsel (WR)
- 4) Galoppwechsel mit Seitenwechsel (WR)
- 5) lope over left lead (TH)
- 6) 2 Galoppwechsel auf der Linie (WR)
- 7) extended lope (RR)
- 8) jog, jog in, 360° turn either way (TH)
- 9) back up, jog out (TH)
- 10) Rechtsgalopp, run down entlang der langen Seite, sliding stop mind. 6m von der Bande entfernt hinter dem Mittelmarker, rollback links, kein Verharren (RN)
- 11) 2 Zirkel Galopp (links), 1 groß und schnell, 2.klein und langsam (RN)
- 12) 4 spins links, 4 spins rechts (RN)

	Back
	Lope
	Jog/Trot
	Walk
	Lead change flying/simple



Erste Westernreiter Union  
Baden-Württemberg e.V.

2.-4. August '19

Mooslargue / F

# Westernreiten

## BW-Landesmeisterschaft



Landesmeister  
in 8 Disziplinen



**BW-Goldcup-Finale**  
Trail • Pleasure • Reining  
Preisgeld: 10.000 €

**EINTRITT FREI**  
**BEWIRTUNG &**  
**BARBETRIEB**

Horseacademy, 19, Rue du Golf, F-68580 Mooslargue



[www.ewu-badenwuerttemberg.de](http://www.ewu-badenwuerttemberg.de)

# GERMAN OPEN

**ewu**<sup>®</sup>  
Erste Westernreiter Union  
Deutschland e.V.

DEUTSCHE MEISTERSCHAFT  
**WESTERNREITEN**  
DEUTSCHE MEISTERSCHAFT  
**MANNSCHAFTEN**  
FINALE **EWU SPORT AWARD**  
**EWU REINING SHOW CUP**  
**150.000 EURO PREISGELD**

90 *Can*



**GUT MATHESHOF**

**KREUTH RIEDEN**

**21-28 SEPTEMBER**

**ERSTE WESTERNREITER UNION DEUTSCHLAND e.V.**